



Parts List

SIRUBA L818F-M1 / H1

**Copyright 2016 © Supra Enterprises Corp.
Wholesale And Retail Sewing Machines Miami FL**

Address: 7630NW 25Th St. Unit 3&4 Miami, FL 33122
Phone numbers: Ph: (305)-406-1067 Fax: (305)-406-1068

SIRUBA®

銀箭牌工業用縫紉機
INDUSTRIAL SEWING MACHINE

L818F

零件圖 PARTS LIST



CE

 高林股份有限公司
KAULIN MFG. CO., LTD.

											
MODEL	SUB-CLASS	NEEDLE PLATE	FEED DOG	PRESSER FOOT	HOOK ASM	BOBBIN CASE ASM	BOBBIN	NEEDLE			
機型	規格	針板	送具	押具	梭頭	梭殼	梭子	針號			
L818F-L1	薄布料	E701	D701	P721	G111	G201	G303	DA*1#9			
L818F-M1	薄至中厚布料	E704	D701	P701	G111	G201	G301	DB*1#11			
L818F-M1B		E704D	D702								
L818F-HM1											
L818F-M1A											
L818F-M1C											
L818F-HM1A	中厚至厚布料 ←(拉輪)	E713	D713	P713-A	G112J	G202	G301	DB*1#21			
L818F-H1									E711	D711	P711
L818F-H1B									E711D	D711D	P711D
L818F-H1A											
L818F-H1C											
L818F-H1R											

H1

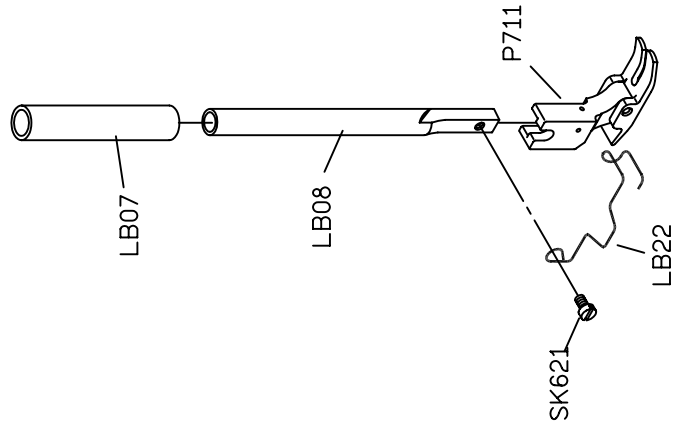

H1R

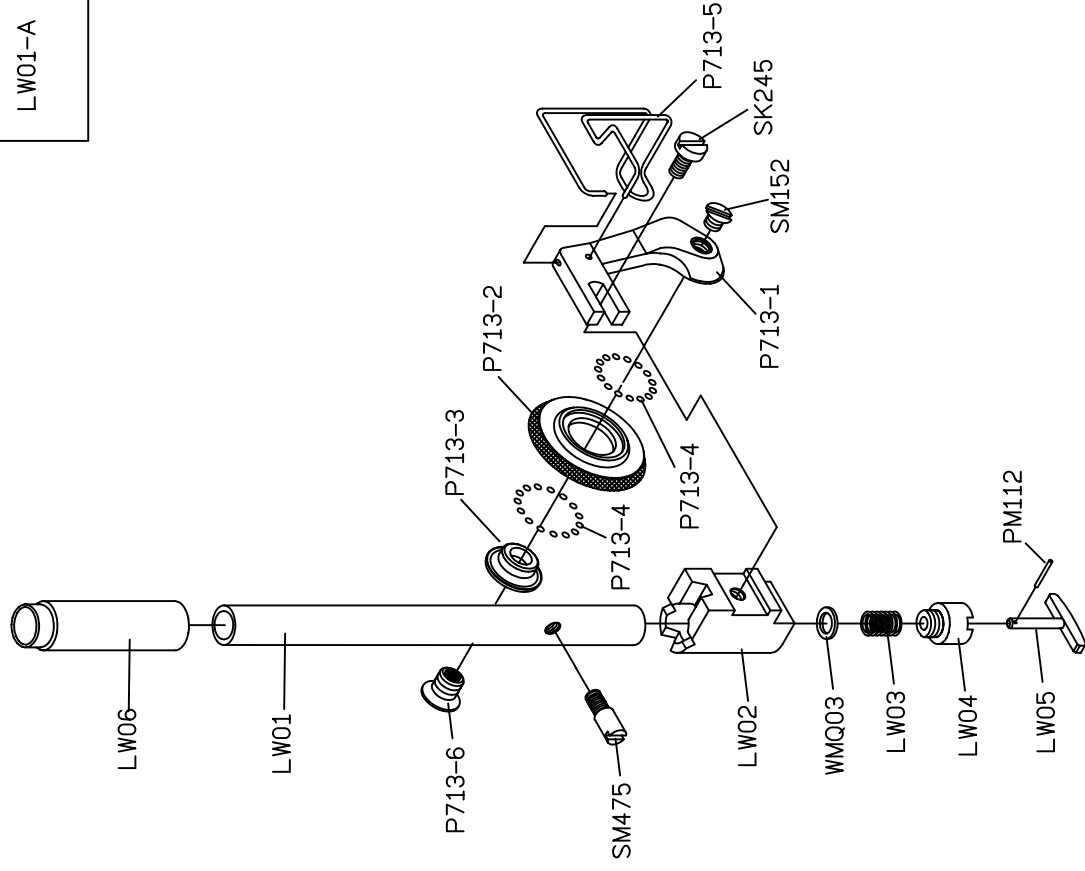

LW01-A

MODEL	SUB-CLASS	SPRING	SPRING	SPRING	SPRING	THREAD GUIDE	THREAD GUIDE	SPRING	THREAD GUIDE	THREAD GUIDE	THREAD GUIDE BAR	EJECTOR PIN	ADJUSTING KNOB
機 型	規 格	控線彈簧	控線彈簧	挑線彈簧	固定片	描環片	壓簧	導線片	導線片	導線桿	頂出銷	調整旋鈕	
L818F /L1	薄布料	LA231	LA22	LA227	—	—	LB204	A LB06	—	—	LB212	LC23G	
H222 /L		LA31	—	LA27		A LA17		B SK241					A LB06
L818F /M1	薄布料 ~ 中厚料	LA31	LA22	LA27	A LA617 B SK690 C LU38	—	LB04	A LB06	—	—	LB212	LC623G	
H222 /M		LA131	—	LA27				A LA617 B SK690 C LU38					A LB06
L818F /H1	中厚料 ~ 厚布料	LA131	LA122	LA27	A LA600 B SK690 C LU38	—	LB104	—	—	A LB100	LB212	LC600G	
H222 /H		LA131	—	LA27						A LA600 B SK690 C LU38			A LB100

型別件對照表 MODEL COMPARE LIST

MODEL 機 型	SUB-CLASS 規 格	REGULATOR 調整銷	CONNECTING ROD SENT 連桿座	FIXED PIN 固定銷	HOOK FIXER 旋梭定位板	COVER 護蓋	THRAD TAKE UP LEVER 天秤	CRANK SHAFT 曲軸	BUSING 襯套	THREAD GUIDE 導線環片
L818F /L1	薄布料	LH11	LC12	LC13	LE14	A LG01	LG13	LG215	LG07	LG09
B SK219										
H222 /L						A LG01				
L818F /HM1	薄布料 ~ 中厚料	LH111	—	—	LE614	A LG101	—	LG615	LG107	LG109
L818F /M1						B SK501				
L818F /M1B		—				A LG01				
H222 /M		LH11	LC12	LC13	LE14	B SK219	LG13	LG15	LG07	LG09
L818F /H1	中厚料 ~ 厚布料	LH111	LC612	LC613	LE614	A LG101	LG13	LG615	LG107	LG109
L818F /H1B						B SK501				
H222 /H		—				A LG101			LG107F	—
		LH111	LC612	LC613	LE614	B SK501	LG113	LG615	LG107	LG109

MODEL	SUB-CLASS	NEEDLE BAR	SPRING	ECCENTRIC	SOLENOID BRACKET	PRESSER PLATE	FIXED PLATE	FIXED PLATE	CONNECTING ROD	CONNECTING ROD
機 型	規 格	針 棒	拉 伸 彈 簧	偏 心 凸 輪	電 磁 閥 座	押 板	固 定 刀	固 定 片	連 桿	連 桿
L818F /L1	薄布料	LG04	LC10	LH06	LU26	LU04	LU05	LU28	LU15 SK662 EM050 SK664	—
L818F /HM1	薄布料 ~ 中厚料	LG104H	—	LH606	LU26	LU04	LU05	LU28	LU15 SK662 EM050 SK664	—
L818F /M1		LG04		LH06					LU15 SK662 EM050 SK664	
L818F /M1B		LG04F		—					—	
L818F /H1		LG104		LH606					LU626	
L818F /H1B	厚布料	LG104F	—	—	—	—	—	—	—	

型別件對照表 MODEL COMPARE LIST

MODEL 機 型	SUB-CLASS 規 格	MOVABLE KNIFE 活動刀	MOVABLE KNIFE 活動刀	MOVABLE KNIFE CONNECTING ROD 活動刀連接桿	MOVABLE KNIFE CONNECTING ROD 活動刀連接桿	PRESSER PLATE 刀座	MOVABLE KNIFE 轉子連接桿	TRIMMER SOLENOID 切線電磁閥
L818F /L1	薄布料	A LU02	—	LU01	—	LU03	LU18	LU25
		B SK660						
L818F /HM1	薄布料 ~ 中厚料	A LU02	—	LU01	—	LU03	LU18	LU25
		B SK660						
L818F /M1	中厚料	A LU02	—	—	—	LU03	LU18	LU25
		B SK660						
L818F /H1	中厚料 ~ 厚布料	A LU602	—	—	LU601	LU603	LU618	LU625
		B SK683						
L818F /H1B	厚布料	—	—	—	—	—	—	—
		—						

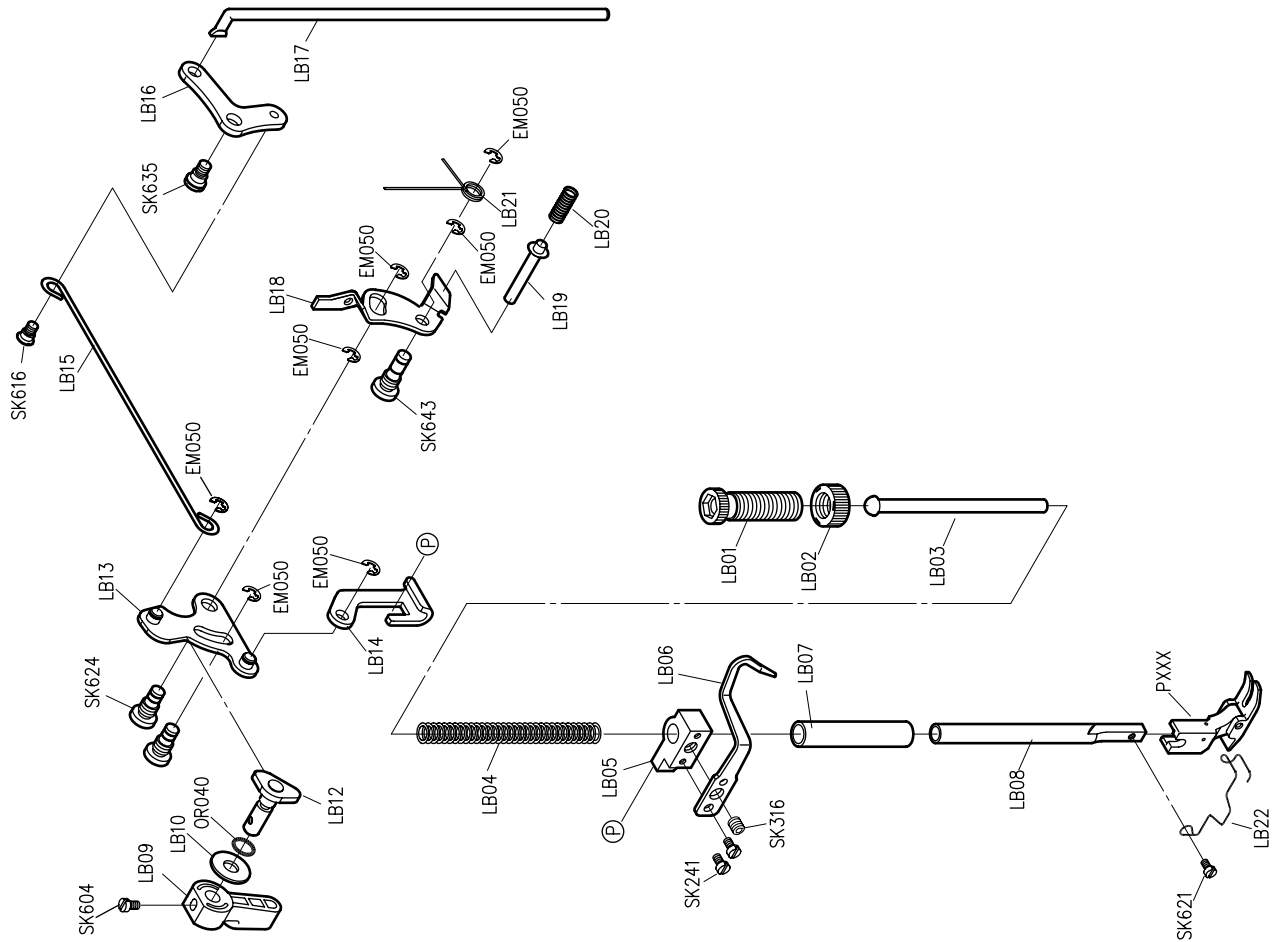

PARTS LIST FOR LB GROUP

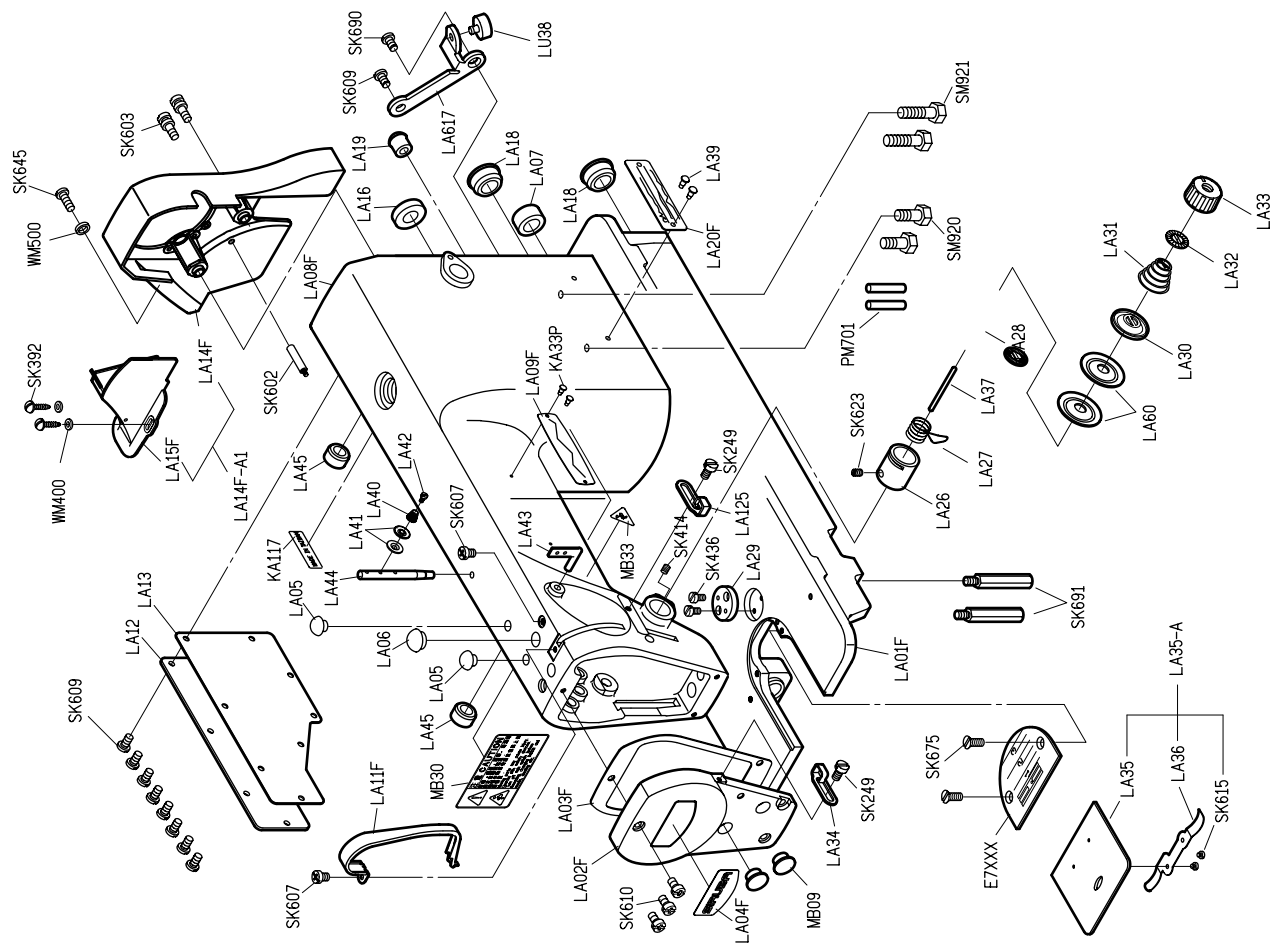

PARTS LIST FOR LA GROUP

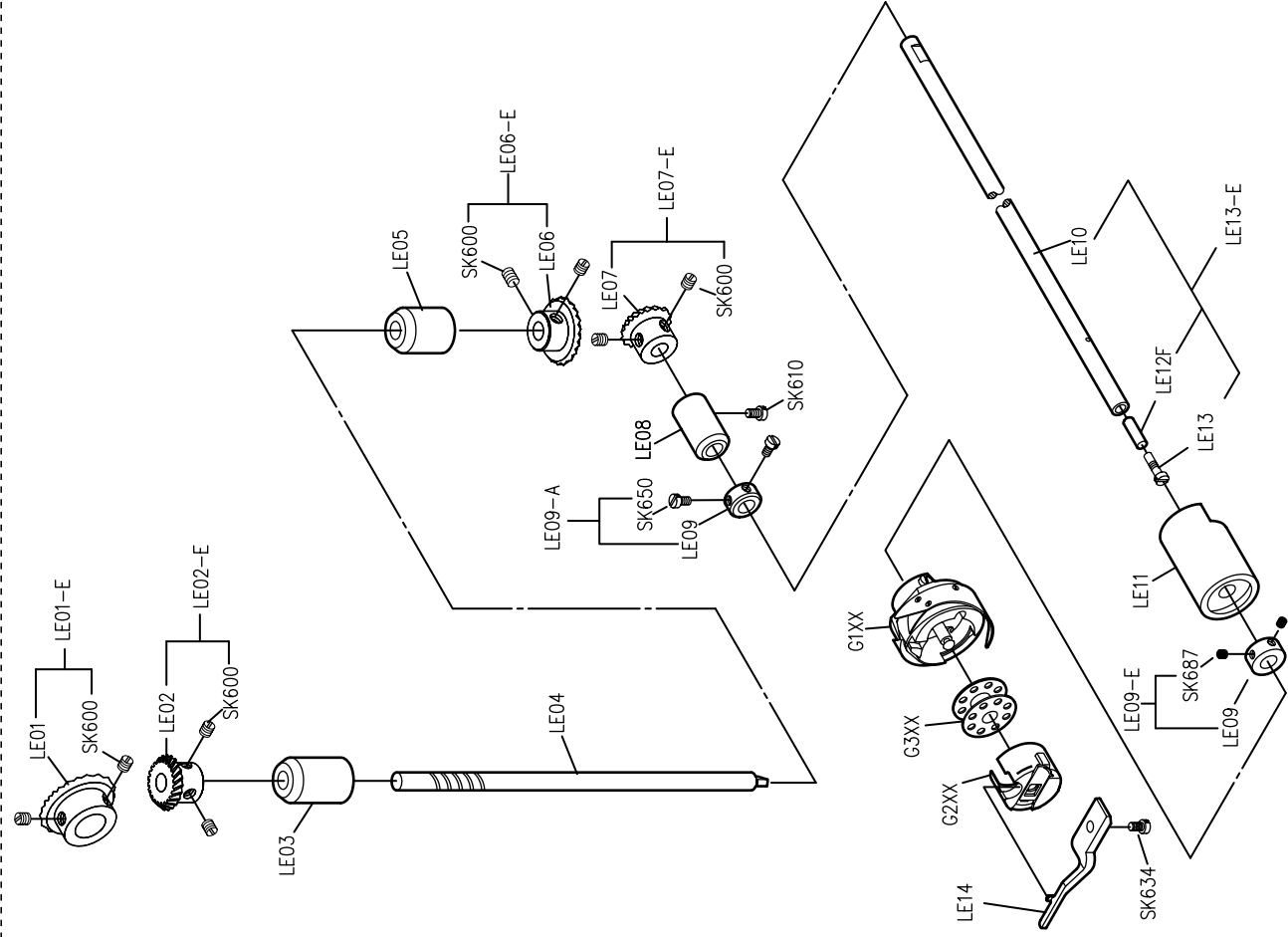

PARTS LIST FOR LE GROUP

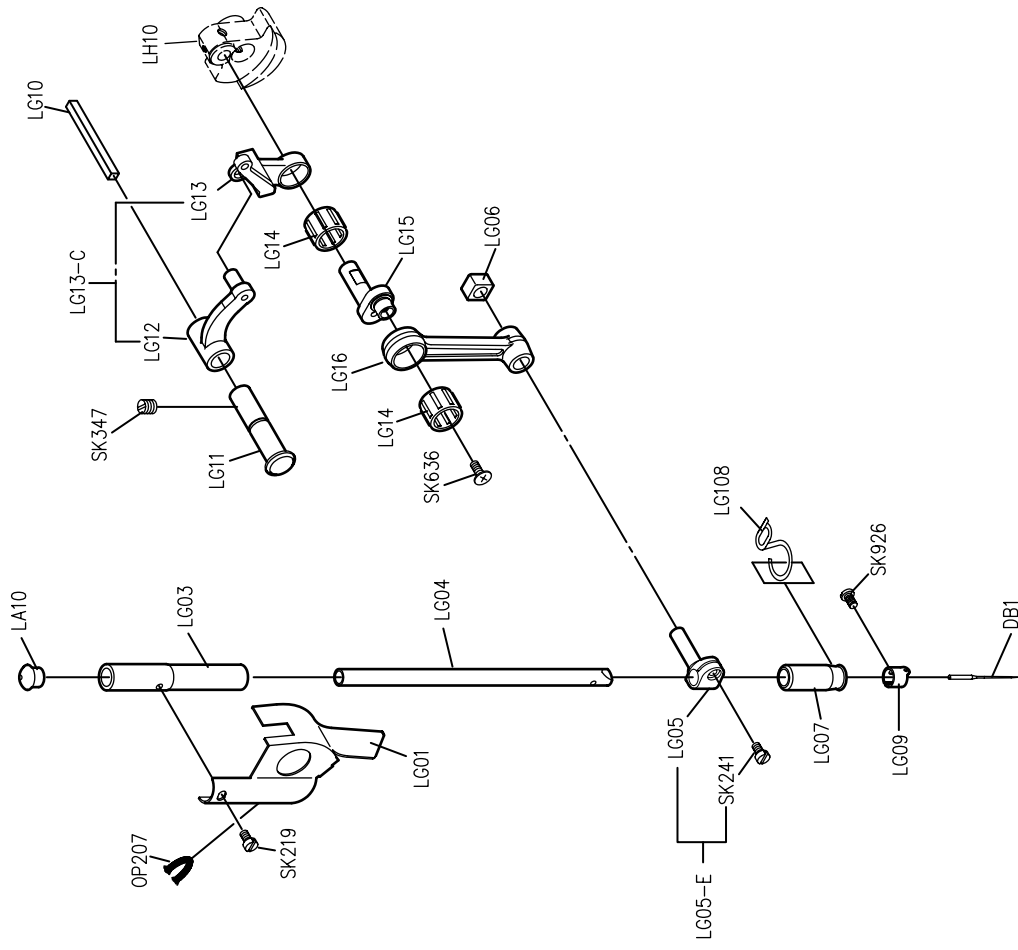

PARTS LIST FOR LG GROUP

PARTS LIST FOR LH GROUP

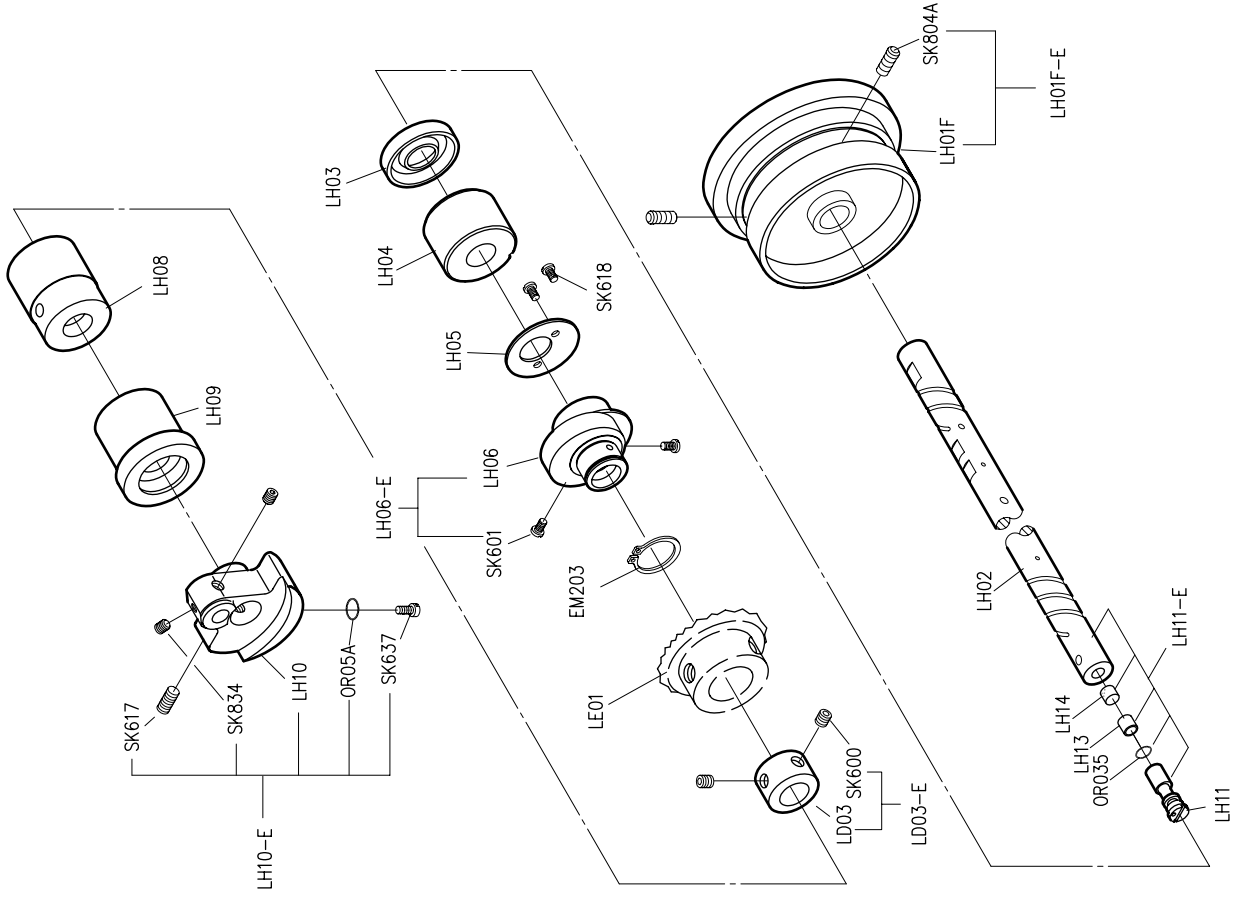

PARTS LIST FOR LL GROUP

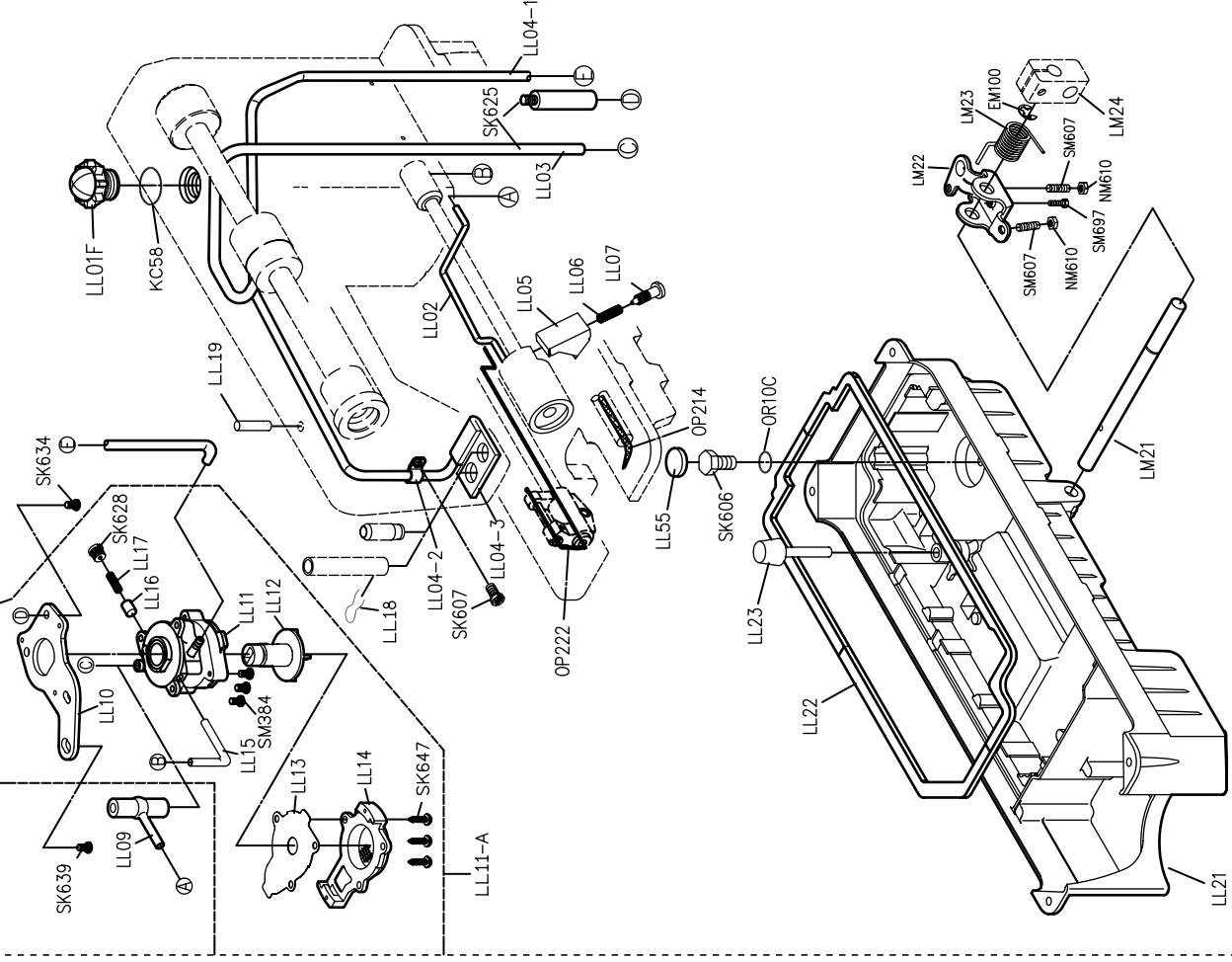

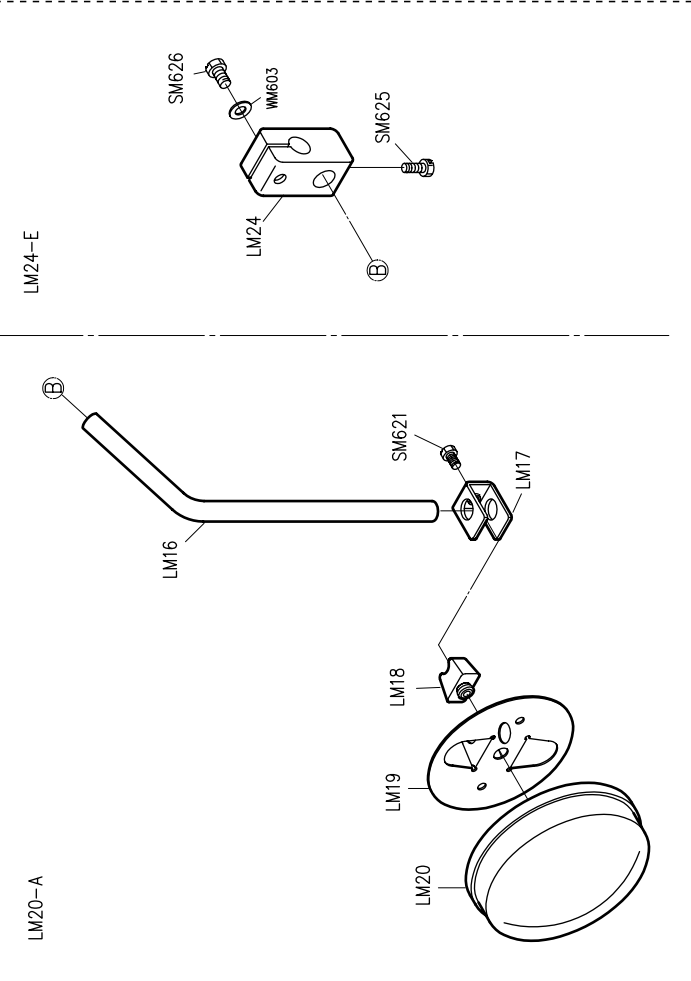
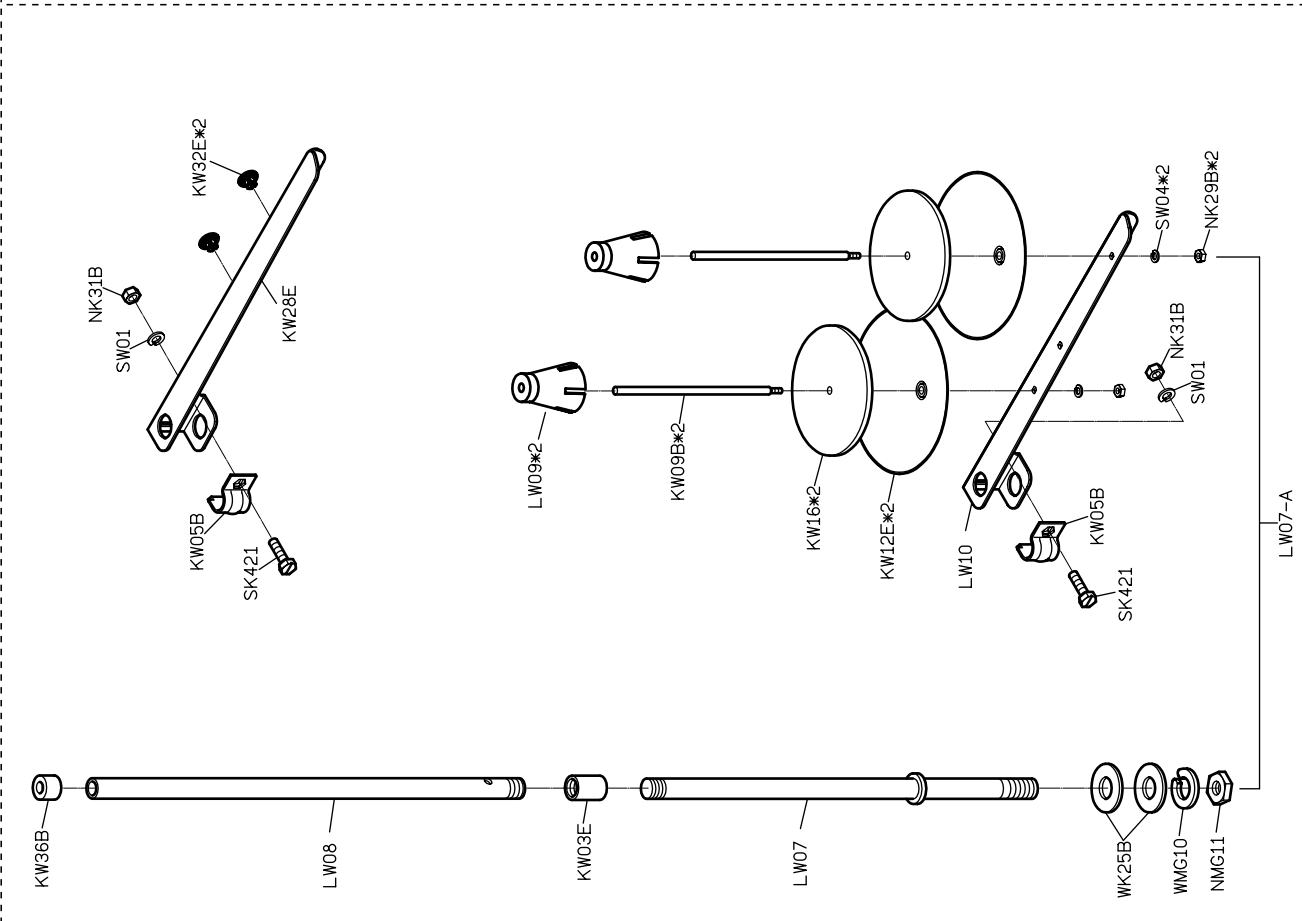
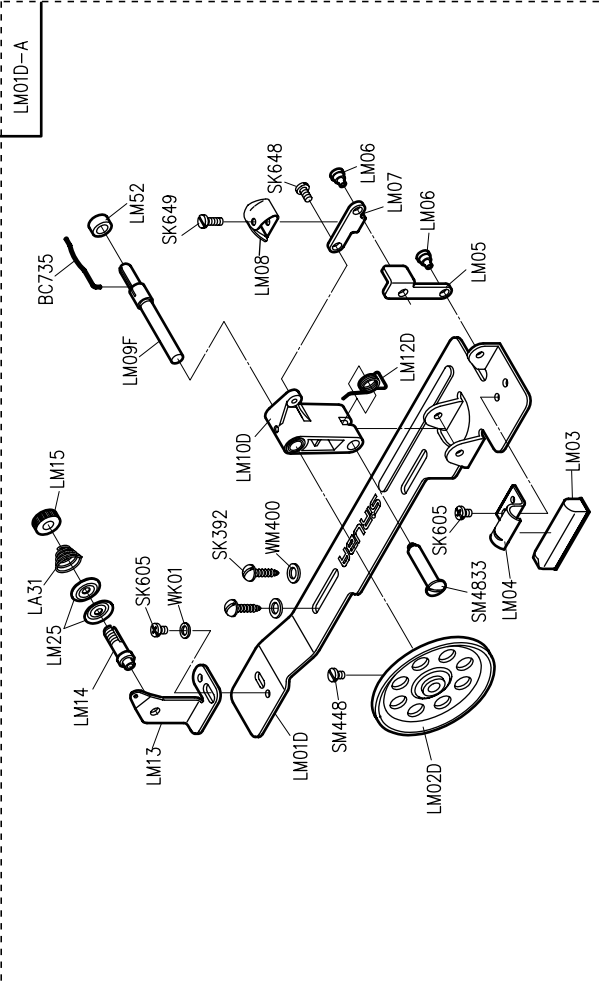











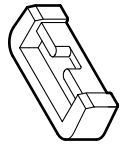
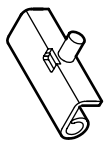

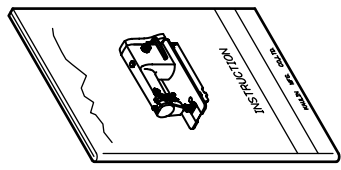
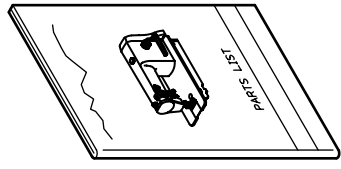
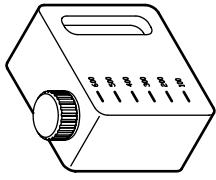

PARTS LIST FOR THREAD STAND GROUP

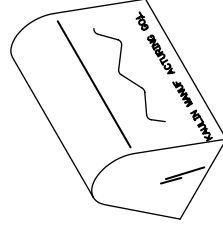
PARTS LIST FOR LM GROUP

PARTS LIST FOR LY GROUP

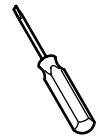
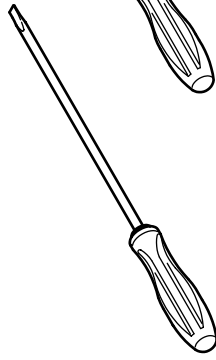
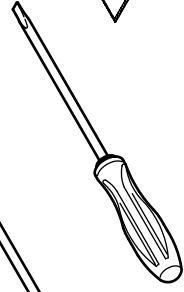
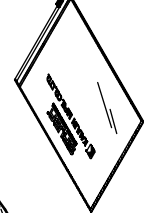
PARTS LIST FOR LZ GROUP

LY01		LY02		YM04*2		LY05*2		YM102*2	
LY08F		LY11		LY21-A		G3XX*2		LY20*8	
MY*2		MY01		MY11		KZ03*1		YM103*2	
MY13		KY16		KY17		KY26F		LZ65	

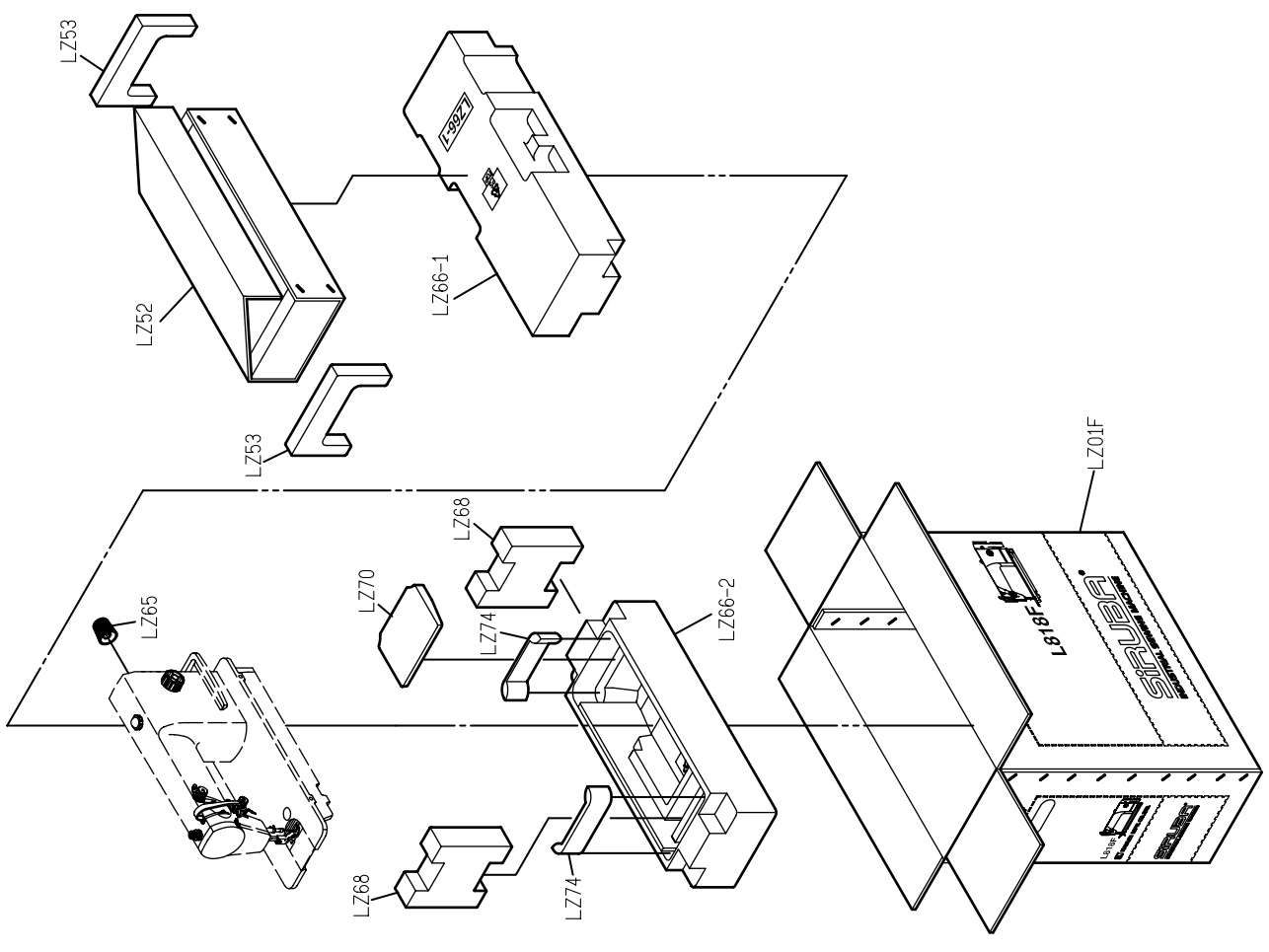



L818F

高林股份有限公司 KAULIN MFG. CO., LTD.